

Mobile LED Examination lamp

130/430/1300 (LED 130F lamp with power supply, suspension arm and 4 leg mobile base)

Focusable LED examination lamp

The LED 130F is a small examination lamp with the advantage of variable focusing. The 70,000 Lux light intensity provides colour rendering index R_a 95. The multiple faceted lenses provide a homogenous light field which can be easily focused by turning the sterilisable handle.

Both power and light intensity are controlled from the lamp head. The LED technology used, ensures greatly reduced operating temperatures compared with traditional halogen bulbs, meaning temperature rise at the operators head area is almost undetectable.

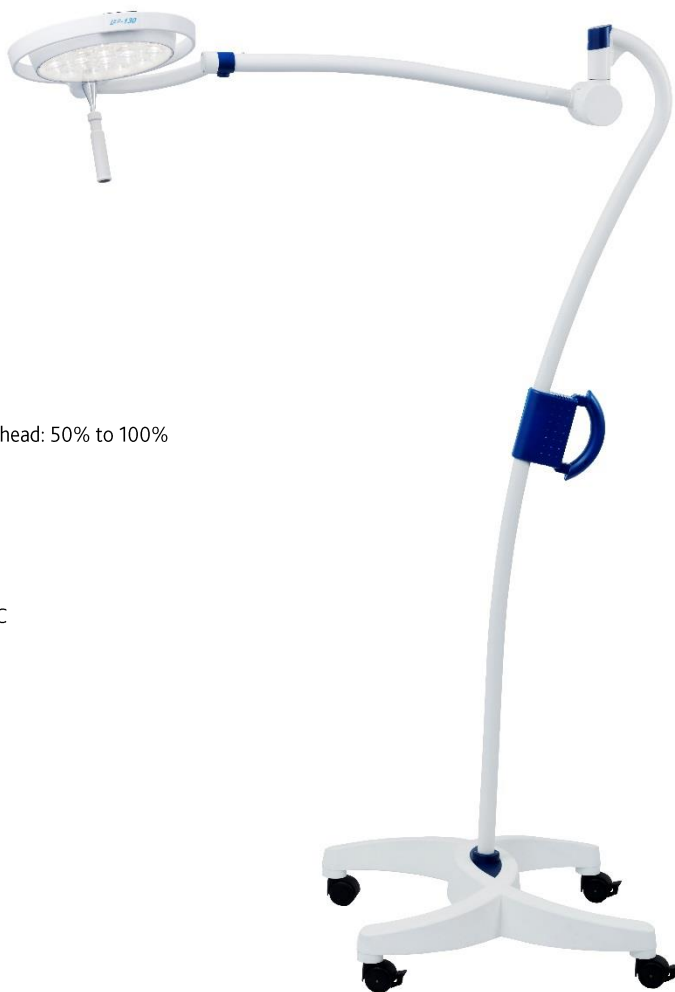

Features

- > Light intensity at 1 metre: 70,000 Lux
- > Electronic light intensity control at lamp head: 50% to 100%
- > Colour rendering index R_a 95
- > Focusable light field size: 14cm to 25 cm
- > Colour temperature: 4300 Kelvin
- > Temperature increase at head area: 0.5 °C
- > Total power consumption: 28W
- > Light source: 19 LED's
- > Life span of over 50,000 hours
- > Diameter of lamp head: 33 cm
- > Detachable sterilizable handle included



Technical Specifications

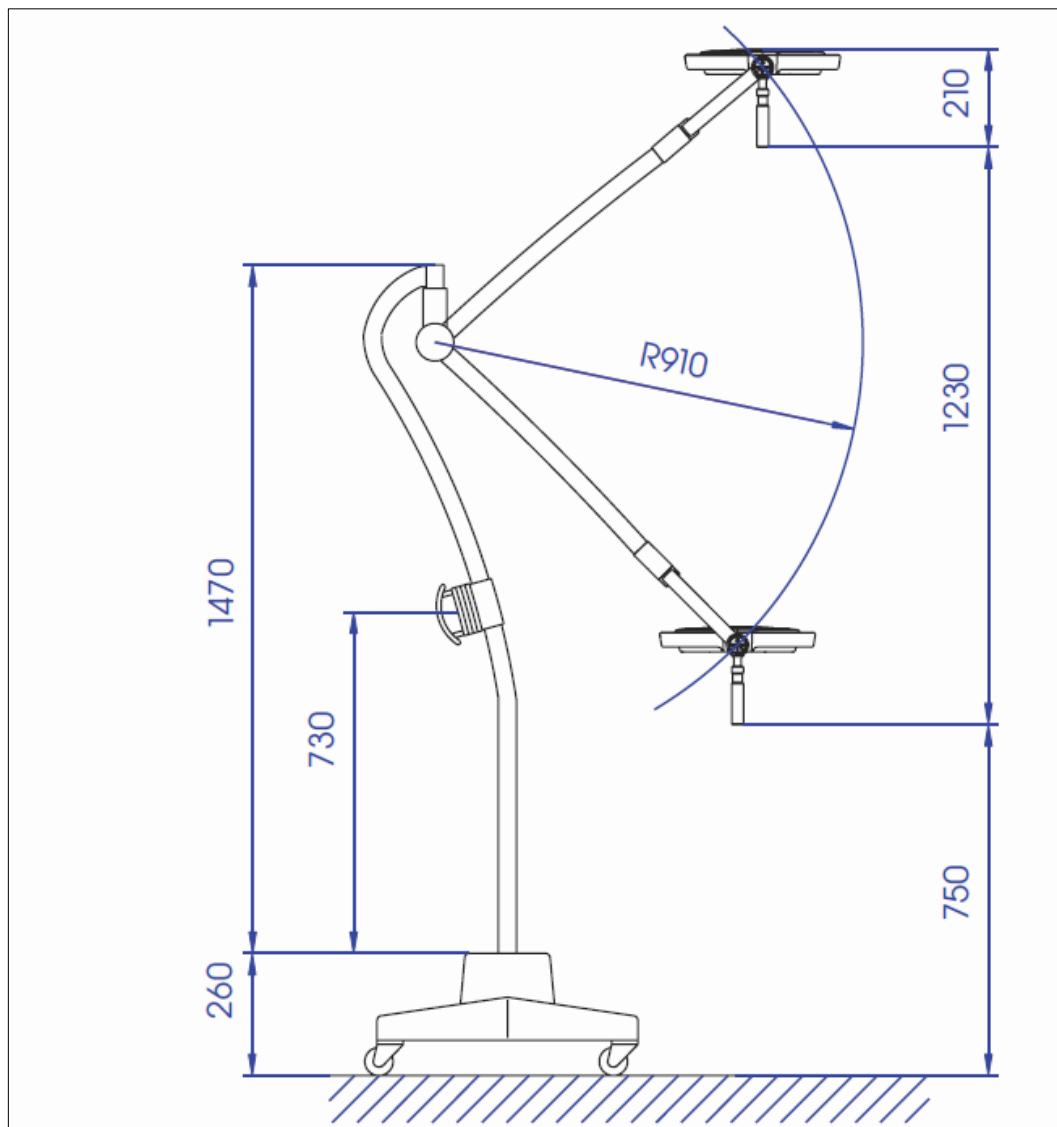

Included:

- Power supply
- LED 130F lamp head
- Suspension arm
- Four castor mobile base and suspension arm support